

RoHS Compliant 1250Mbps Gigabit Interface Converters (GBIC) Transceiver Module for Gigabit Ethernet

GBIC-1250B5QR (10km)

Features

- Compliant with Gigabit Interface Converter (GBIC) Revision 5.4
- Compliant with proposed specifications for IEEE 802.3z/Gigabit Ethernet.
- GBIC-1250B5QR compliant with the 1.0625GBd FC-PI 100-SM-LC-L Rev.13
- Dual 5V and 3.3V Power Supply Operation
- TTL Logic TX_DISABLE / TX_FAULT / RX_LOS functions
- Class 1 Laser Product Compliant with the Requirements of IEC 60825-1 and IEC 60825-2
- Hot-Pluggable
- RoHS Compliant per Directive 2002/95/EEC

Description

The GBIC-1250B5QR is compliant with GBIC interface converters specification Rev. 5.4, as well as Gigabit Ethernet standard as specified in IEEE 802.3.

Delta's GBIC transceiver family uses a 20-pin connector to allow hot plug capability. The system designer can make configuration changes or maintenance simply by plugging in different type of converters without removing the power supply from the host system.

Applications

- 1.25 Gigabit Ethernet
- Fiber Channel
- Switch to Switch Interface
- File server interface

Performance

GBIC-1250B5QR:

1310 FP laser, up to 10km in SMF

Absolute Maximum Ratings

Parameter	Symbol	Min.	Typ.	Max.	Unit	Notes
Storage Temperature	T _s	-40		85	°C	
Supply Voltage	V _{CC}	0		6	V	

Recommended Operating Conditions

Parameter	Symbol	Min.	Typ.	Max.	Unit	Notes
Ambient Operating Temperature	T _A	-5		70	°C	
Supply voltage	V _{CC}	3.15 / 4.75	3.3 / 5	3.45 / 5.25	V	
Total Supply Current	I _s			300	mA	
Data Output Load	R _{DL}		75		Ω	
Relative Humidity (non condensation)	-	5		85	%	

Transmitter Electro-Optical Performance Specifications:

(T_A=-5 °C to 70 °C, V_{CC}=3.15V to 3.45V or V_{CC}=4.75V to 5.25V)

Parameter	Symbol	Min.	Typ.	Max.	Unit	Note
Transmitter						
Transmitter Differential Input Voltage	V _{DT}	0.5		2.4	V	1
Transmitter Disable Input-High	V _{DISH}	2		V _{CC} +0.3	V	
Transmitter Disable Input-Low	V _{DISL}	0		0.8	V	
Transmitter Fault Pull up Resistor	R _{TX_FAULT}	4.7		10	kΩ	2
Transmitter Fault Output-High	V _{TXFH}	2		V _{CC} +0.3	V	2
Transmitter Fault Output-Low	V _{TXFL}	0		0.8	V	2
Receiver						
Receiver Differential Output Voltage	V _{DR}	0.35		2	V	3
Receiver LOS Load	R _{RXLOS}	4.7		10	kΩ	2
LOS Output Voltage-High	V _{LOSH}	2		V _{CC} +0.3	V	2
LOS Output Voltage-Low	V _{LOSL}	0		0.8	V	2
Output Data Rise / Fall Time	t _r / t _f			350	psec	4

Notes:

1. Internally AC coupled and terminated to 150Ohm differential load.
2. Pull up to V_{CC} on host Board
3. Internally AC coupled, but requires a 150Ohm differential termination at or internal to Serializer/ Deserializer.
4. These are 20%~80% values.

Optical Characteristics

 (T_A=-5 °C to 70 °C, V_{CC}=3.15V to 3.45V or V_{CC}=4.75V to 5.25V, Data Rate=1250Mb/sec, PRBS=2⁷-1NRZ)

Parameter	Symbol	Min.	Typ.	Max.	Unit	Notes
Transmitter						
Average Launched Power GBIC-1250B5QR	P _O	-9.5		-3	dBm	
Optical extinction ratio	ER	9			dB	
Center wavelength GBIC-1250B5QR	λ _c	1274	1310	1355	nm	
Spectral Width GBIC-1250B5QR (RMS)	σ			4	nm	
Optical Rise/ Fall Time	t _r /t _f			260	psec	2
Receiver						
Optical input sensitivity (avg.) GBIC-1250B5QR	P _{IN}			-20	dBm	1
Optical input saturation (avg.) GBIC-1250B5QR	P _{SAT}	-3			dBm	
Optical Wavelength GBIC-1250B5QR	λ _c	1274	1310	1355	nm	
Signal Detect- Assert GBIC-1250B5QR	P _A			-20	dBm	
Signal Detect- Deassert GBIC-1250B5QR	P _D	-40			dBm	
Signal detect- Hysteresis	P _A -P _D	0.5			dB	

Note:

- The sensitivity is provided at a BER of 1×10⁻¹² or better with an input signal consisting of 1250Mb/s, 2⁷-1 PRBS and ER=9dB.
- These are 20%~80% values.

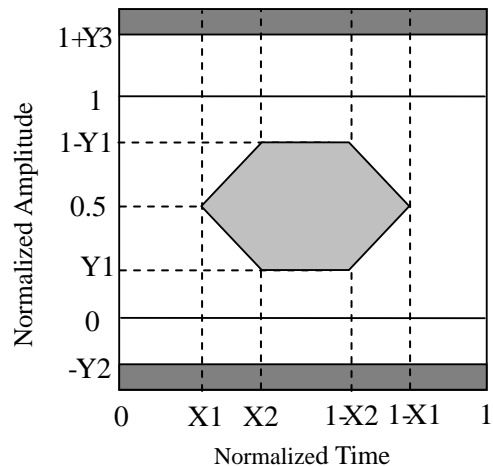

Pin Out Table

Pin Name	Pin#	Sequence	Sequence	Pin#	Pin Name
RX_LOS	1	2	1	11	RGND
RGND	2	2	1	12	-RX_DAT
RGND	3	2	1	13	+RX_DAT
MOD_DEF(0)	4	2	1	14	RGND
MOD_DEF(1)	5	2	2	15	VDDR
MOD_DEF(2)	6	2	2	16	VDDT
TX_DISABLE	7	2	1	17	TGND
TGND	8	2	1	18	+TX_DAT
TGND	9	2	1	19	-TX_DAT
TX_FAULT	10	2	1	20	TGND

Overview of internal interface signal Definition

Pin Name	Pin #	Name/Function	Signal Specification
Receiver Signals			
RGND	2,3,11,14	Receiver Ground (may be connected with TGND in GBIC)	Ground, to GBIC
VDDR	15	Receiver +5 volt (may be connected with VDDT in GBIC)	Power, to GBIC
-RX_DAT	12	Receive Data, Differential PECL	High speed serial, from GBIC
+RX_DAT	13	Receive Data, Differential PECL	High speed serial, from GBIC
RX_LOS	1	Receiver Loss of Signal, logic high, open collector compatible, 4.7 K to 10 K Ohm pullup to VDDT on host	Low speed, from GBIC
Transmitter Signals			
TGND	8,9,17,20	Transmitter Ground (may be connected with RGND internally)	Ground, to GBIC
VDDT	16	Transmitter +5 volt (may be connected with VDDR in GBIC)	Power, to GBIC
+TX_DAT	18	Transmit Data, Differential PECL	High speed serial, to GBIC
-TX_DAT	19	Transmit Data, Differential PECL	High speed serial, to GBIC
TX_DISABLE	7	Transmitter Disable, logic high, open collector compatible, 4.7 K to 10 K Ohm pullup to VDDT on GBIC	Low speed, to GBIC
TX_FAULT	10	Transmitter Fault, logic high, open collector compatible, 4.7 K to 10 K Ohm pullup to VDDT on host	Low speed, from GBIC
Control Signals			
MOD_DEF(0)	4	GBIC module definition and presence, bit 0, 4.7 K to 10 K Ohm pullup to VDDT on host	Low speed, from GBIC
MOD_DEF(1)	5	GBIC module definition and presence, bit 1, 4.7 K to 10 K Ohm pullup to VDDT on host	Low speed, from GBIC
MOD_DEF(2)	6	GBIC module definition and presence, bit 2, 4.7 K to 10 K Ohm pullup to VDDT on host	Low speed, from GBIC

Recommend Circuit Schematic

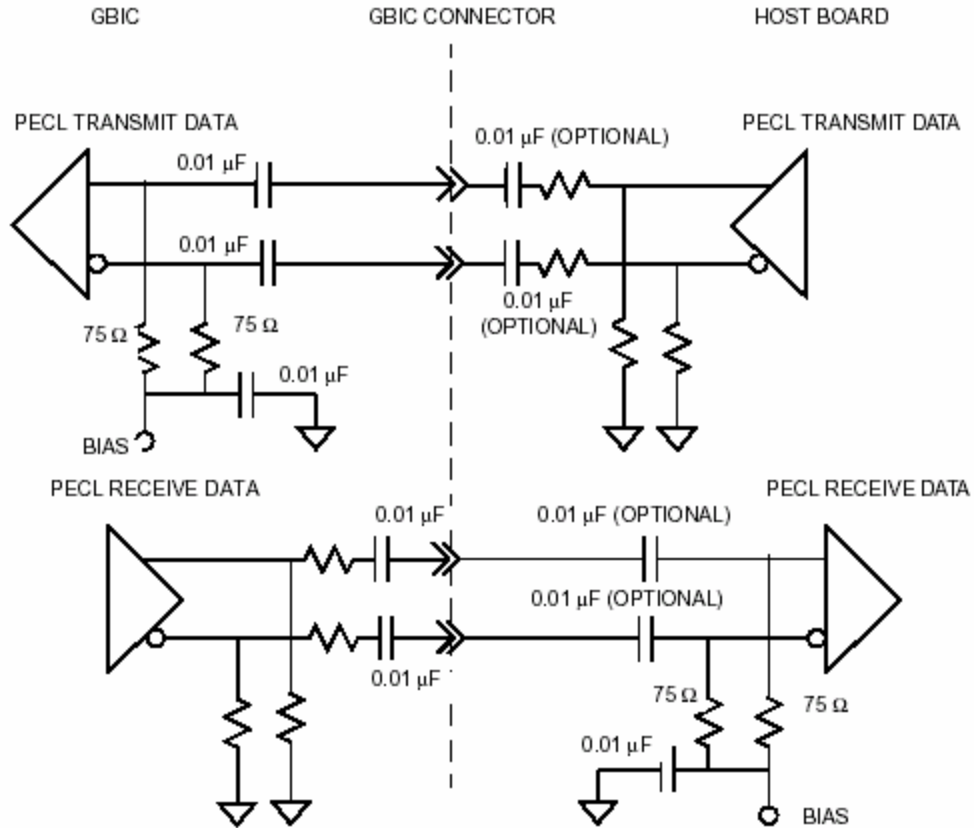

GBIC module definition parameters

Module Definition	MOD_DEF(0) Pin 4	MOD_DEF(1) Pin 5	MOD_DEF(2) Pin 6	Interpretation by host Reference
0	NC	NC	NC	GBIC not present clause
1	NC	NC	TTL LOW	Copper Style 1 or Style 2 connector, 1.0625 Gbd, 100-TW-EL-S or 100-TP-EL-S, active inter-enclosure connection and IEEE802.3 1000BASE-CX
2	NC	TTL LOW	NC	Copper Style 1 or Style 2 connector, 1.0625 Gbd, 100-TW-EL-S, or 100-TP-EL-S, active or passive intra-enclosure connection
3	NC	TTL LOW	TTL LOW	Optical LW, 1.0625 Gbd 100-SM-LC-L
4	TTL LOW	SCL	SDA	Serial module definition protocol
5	TTL LOW	NC	TTL LOW	Optical SW, 1.0625 Gbd 100-M5-SN-I or 100-M6-SN-I
6	TTL LOW	TTL LOW	NC	Optical LW, 1.0625 Gbd 100-SM-LC-L and similar to 1.25 Gbd IEEE802.3z 1000BASE-LX, single mode
7	TTL LOW	TTL LOW	TTL LOW	Optical SW, 1.0625 Gbd 100-M5-SN-I or 100-M6-SN-I and 1.25 Gbd, IEEE 802.3z, 1000BASE-SX

GBIC timing parameters for GBIC management

Parameter	Symbol	Min.	Max.	Unit	Unit Conditions
TX_DISABLE assert time	t_off		10	μsec	Rising edge of TX_DISABLE to fall of output signal below 10% of nominal
TX_DISABLE negate time	t_on		1	mec	Falling edge of TX_DISABLE to rise of output signal above 90% of nominal
Time to initialize, includes reset of TX_FAULT	t_init		300	msec	From power on or hot plug fter V DD T > 4.75 volts or From negation of TX_DISABLE during reset of TX_FAULT.
TX_FAULT from fault to assertion	t_fault		100	μsec	From occurrence of fault (out-put safety violation or V DD T < 4.5 volts)
TX_DISABLE time to start reset	t_rest	10		μsec	TX_DISABLE HIGH before TX_DISABLE set LOW
RX_LOS assert delay	t_loss_on		100	μsec	From detection of loss of signal to assertion of RX_LOS
RX_LOS negate delay	t_loss_off		100	μsec	From detection of presence of signal to negation of RX_LOS

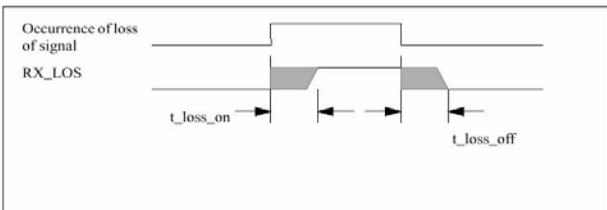
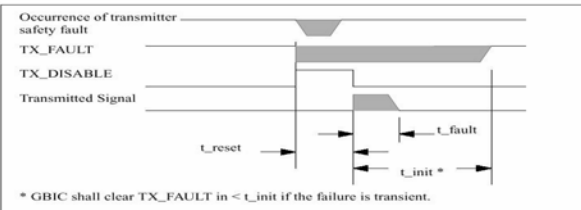
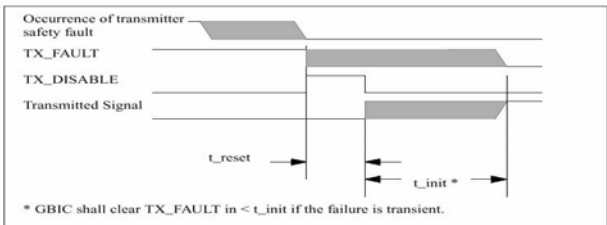
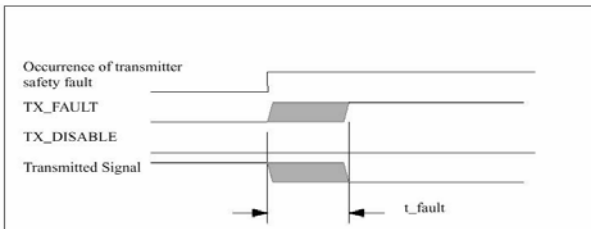
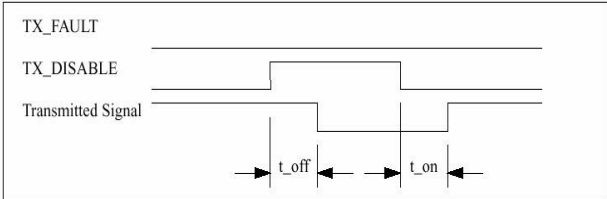
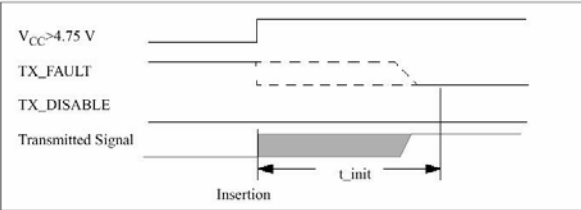
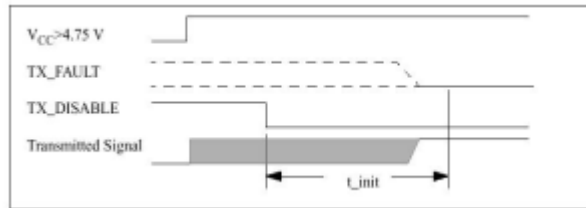
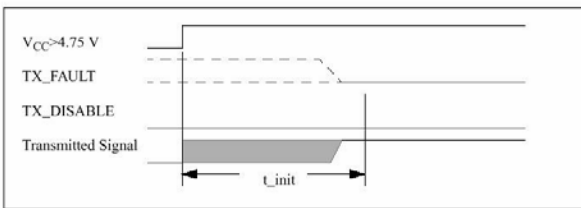
GBIC timing parameters:

GBIC-1250B5QR EEPROM Serial ID Memory Contents (2-Wire Address A0h)

Address	Hex	ASCII	Address	Hex	ASCII	Address	Hex	ASCII	Address	Hex	ASCII	Address	Hex	ASCII	Address	Hex	ASCII
00	01		25	20		50	35	5	75	SN		100	00		125	00	
01	04		26	20		51	51	Q	76	SN		101	00		126	00	
02	01		27	20		52	52	R	77	SN		102	00		127	00	
03	00		28	20		53	20		78	SN		103	00				
04	00		29	20		54	20		79	SN		104	00				
05	00		30	20		55	20		80	SN		105	00				
06	02		31	20		56	41	A	81	SN		106	00				
07	12		32	20		57	20		82	SN		107	00				
08	00		33	20		58	20		83	SN		108	00				
09	01		34	20		59	20		84	DC	Note 3	109	00				
10	01		35	20		60	05		85	DC		110	00				
11	01		36	00		61	1E		86	DC		111	00				
12	0D		37	00		62	00		87	DC		112	00				
13	00		38	00		63	CS1	Note 1	88	DC		113	00				
14	0A		39	00		64	00		89	DC		114	00				
15	64		40	47	G	65	1A		90	DC		115	00				
16	00		41	42	B	66	05		91	DC		116	00				
17	00		42	49	I	67	05		92	00		117	00				
18	00		43	43	C	68	SN	Note 2	93	00		118	00				
19	00		44	2D	-	69	SN		94	00		119	00				
20	44	D	45	31	1	70	SN		95	CS2	Note 4	120	00				
21	45	E	46	32	2	71	SN		96	00		121	00				
22	4C	L	47	35	5	72	SN		97	00		122	00				
23	54	T	48	30	0	73	SN		98	00		123	00				
24	41	A	49	42	B	74	SN		99	00		124	00				

Notes:

- 1) Byte 63 (CS1): Check sum of bytes 0-62.
- 2) Byte 68-83 (SN): Serial number.
- 3) Byte 84-91 (DC): Date code.
- 4) Byte 95 (CS2): Check sum of bytes 64-94.

Package Outline Drawing

GBIC-1250B5QR

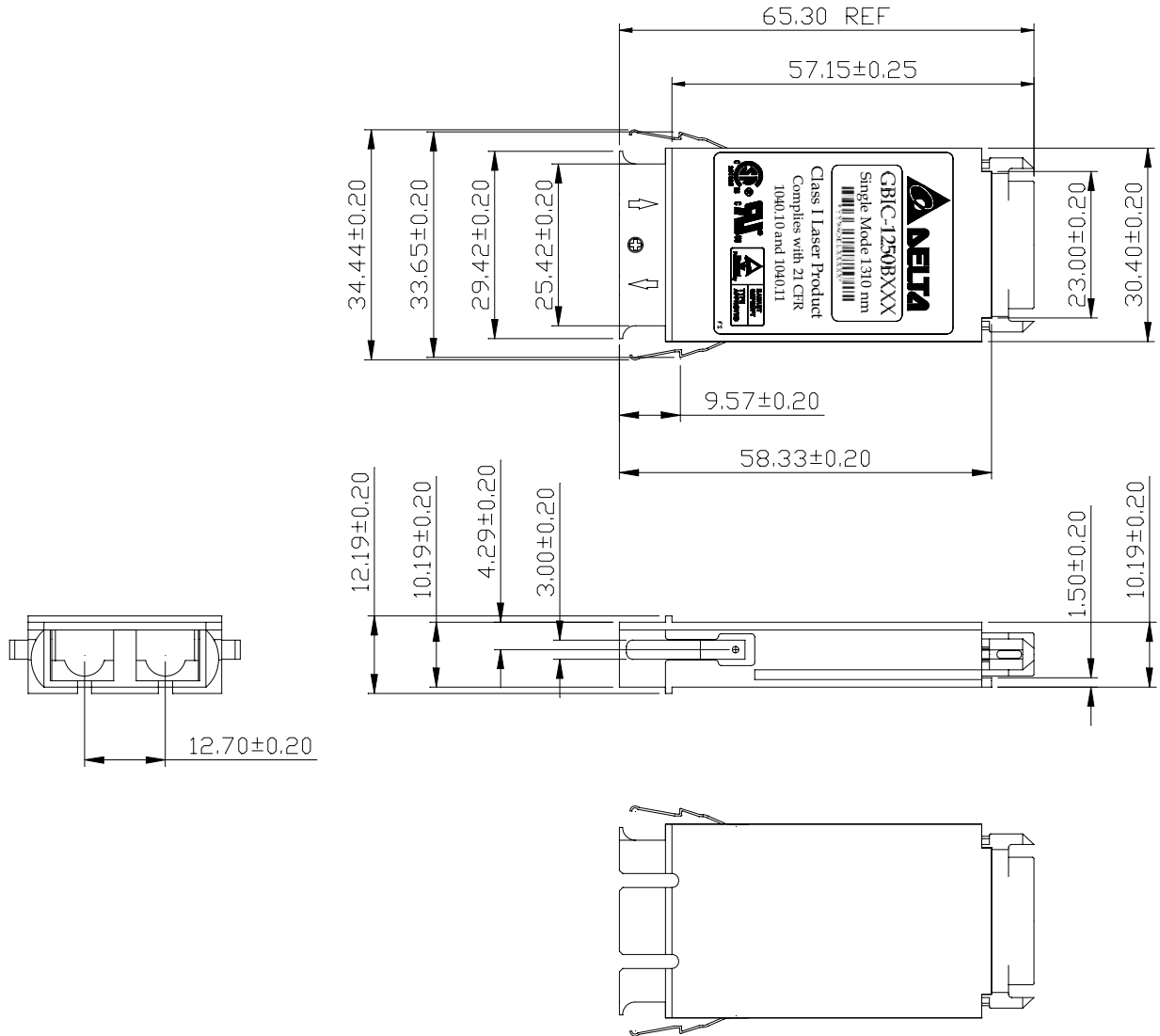

Regulatory Compliance

Test Item	Reference	Qty'	Evaluation
(#1) Electromagnetic Interference EMC	FCC Class B EN 55022 Class B CISPR 22	5	(1) Satisfied with electrical characteristics of product spec. (2) No physical damage
(#2) Immunity : Radio Frequency Electromagnetic Field	EN 61000-4-3 IEC 1000-4-3	5	
(#3) Immunity : Electrostatic Discharge to the Duplex SC Receptacle	EN 61000-4-2 IEC 1000-4-2 IEC 801.2	5	
(#4) Electrostatic Discharge to the Electrical Pins	MIL-STD-883C Method 3015.4 EIAJ#1988.3.2B Version 2, Machine model	5	

Ordering information for GBIC modules**GBIC-1250X₁X₂X₃X₄**

X1: Light source types
A: Multi-mode
B: 1310nm Single-mode
D: 1550nm Single-mode

X3: Distance:
F: 500m
Q: 10km
L: 25km
M: 40km
W: 70km
R: 80km
V: 100km

X2: Power Supply Voltage
5: 3.3 and 5V

X4: R: RoHS Compliant
Others: customized parts

Available Products

- **GBIC-1250A5FR**: Dual supply voltage (3.3/5V), 850nm VCSEL, 50um MMF 500m.
- **GBIC-1250B5QR**: Dual supply voltage (3.3/5V), 1310nm MQW FP LD, SMF 10km.
- **GBIC-1250B5LR**: Dual supply voltage (3.3/5V), 1310nm DFB-LD, SMF 25km.
- **GBIC-1250D5MR**: Dual supply voltage (3.3/5V), 1550nm DFB-LD, SMF 40km.
- **GBIC-1250D5WR**: Dual supply voltage (3.3/5V), 1550nm DFB-LD, SMF 70km.
- **GBIC-1250D5RR**: Dual supply voltage (3.3/5V), 1550nm DFB-LD, SMF 80km..
- **GBIC-1250D5VR**: Dual supply voltage (3.3/5V), 1550nm DFB-LD, SMF 100km.